



Modular Cooking Range Line 700XP 6-Burner Gas Boiling Top on Open Base 1200mm

ITEM # _____

MODEL # _____

NAME # _____

SIS # _____

AIA # _____



371179 (E7GCGL6CO0)

6-Burner (5,5 kW each) gas
Range on Open Base

Short Form Specification

Item No.

High efficiency flower flame burners with flame regulator and protected pilot light. Flame failure device as standard on burners to protect against accidental extinguishing. Exterior panels in stainless steel with Scotch Brite finish. Pan supports in heavy duty cast iron. One piece pressed work top in 1.5 mm thick stainless steel. Right-angled side edges to allow flush-fitting junction between units.

Open base to store pots, pans, sheet pans etc. Constructed in stainless steel with Scotch Brite finish. Delivered with 50 mm height adjustable feet.

Main Features

- Unit to be mounted on open base cupboards, bridging supports or cantilever systems.
- The six 5.5 kW high efficiency flower flame burners allow the flame to adapt to different size pans.
- Gas appliance supplied for use with natural or LPG gas, conversion jets supplied as standard.
- Large sized pan support in cast iron (stainless steel as option) with long center fins to allow the use of the largest down to the smallest pans.
- Pan supports in cast iron are washable in a dishwasher.
- Burners to feature flame regulator.
- Flame failure device on each burner protects against gas leakage when accidental extinguishing of the flame occurs.
- Protected pilot light.
- IPx4 water protection.
- Unit can be easily installed below other 700 line top models.
- Unit delivered with 50 mm height adjustable feet in Stainless steel.
- Open base compartment for storage of pots, pans, sheet pans, etc.
- Doors with handles, drawers, heating kits and runners for GN containers can be ordered separately.
- Control knobs provide smooth, continuous rotation from min to max power level.

Construction

- All exterior panels in Stainless Steel with Scotch Brite finishing.
- One piece pressed 1.5 mm work top in Stainless steel.
- Model has right-angled side edges to allow flush fitting joints between units, eliminating gaps and possible dirt traps.
- Constructed in Stainless steel with Scotch Brite finish to meet the highest hygiene standards.

Optional Accessories

- Junction sealing kit PNC 206086
- Draught diverter, 150 mm diameter PNC 206132
- Matching ring for flue condenser, 150 mm diameter PNC 206133
- Kit 4 wheels - 2 swivelling with brake - it is mandatory to install Base support and wheels PNC 206135
- Flanged feet kit PNC 206136
- Frontal kicking strip for concrete installation, 1200mm PNC 206151
- Frontal kicking strip for concrete installation, 1600mm PNC 206152
- Frontal kicking strip, 1200mm (not for refr-freezer base) PNC 206178
- Frontal kicking strip, 1600mm (not for refr-freezer base) PNC 206179

APPROVAL: _____



Experience the Excellence
www.electroluxprofessional.com

• FRONTAL HANDRAIL 1200 MM	PNC 206191	<input type="checkbox"/>
• FRONTAL HANDRAIL 1600 MM	PNC 206192	<input type="checkbox"/>
• Kit 4 feet for concrete installation (not for 900 line free standing grill)	PNC 206210	<input type="checkbox"/>
• Right and left side handrails	PNC 206240	<input type="checkbox"/>
• 2 supports with side runners for 4 GN 1/1 containers for open base cupboards (multifunctional cookers, solid top and gas ranges with cupboard)	PNC 206244	<input type="checkbox"/>
• Central support for installation of drawers and grid (on 800/1200mm bases) and of doors (on 1200mm bases)	PNC 206245	<input type="checkbox"/>
• Flue condenser for 1 module, 150 mm diameter	PNC 206246	<input type="checkbox"/>
• Pair of side kicking strips	PNC 206249	<input type="checkbox"/>
• Electric heating kit for cupboards	PNC 206259	<input type="checkbox"/>
• Single burner smooth plate for direct cooking - fits frontal burners only	PNC 206260	<input type="checkbox"/>
• Single burner ribbed plate for direct cooking- fits frontal burners only	PNC 206261	<input type="checkbox"/>
• Single burner radiant plate for pan support	PNC 206264	<input type="checkbox"/>
• Pair of side kicking strips for concrete installation	PNC 206265	<input type="checkbox"/>
• Water column with swivel arm (water column extension not included)	PNC 206289	<input type="checkbox"/>
• Water column extension for 700 line	PNC 206291	<input type="checkbox"/>
• Stainless steel double grid for 2 burners	PNC 206297	<input type="checkbox"/>
• Chimney upstand, 1200mm	PNC 206306	<input type="checkbox"/>
• Wok pan support for open burners (700/900)	PNC 206363	<input type="checkbox"/>
• Base support for feet or wheels - 800mm (700/900)	PNC 206367	<input type="checkbox"/>
• Base support for feet or wheels - 1200mm (700/900)	PNC 206368	<input type="checkbox"/>
• Base support for feet or wheels - 1600mm (700/900)	PNC 206369	<input type="checkbox"/>
• Rear paneling - 1200mm (700/900)	PNC 206376	<input type="checkbox"/>
• Kit town gas nozzles (G150) for 700 solid top and burner	PNC 206388	<input type="checkbox"/>
• Chimney grid net, 500mm (700XP/900)	PNC 206402	<input type="checkbox"/>
• Kit G.25.3 (NI) gas nozzles for 700 top and - freestanding on oven - gas cookers	PNC 206460	<input type="checkbox"/>
• Pressure regulator for gas units	PNC 927225	<input type="checkbox"/>

Front

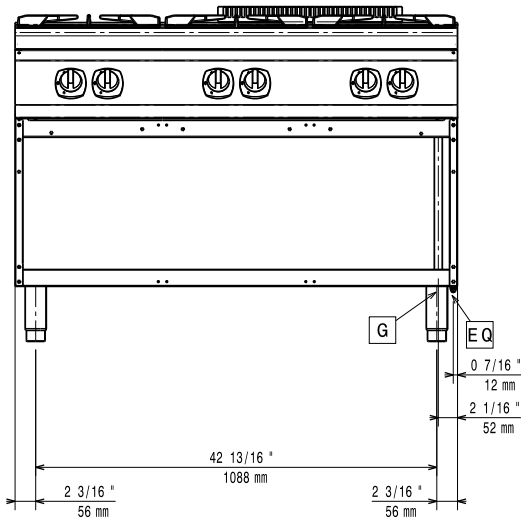

Side

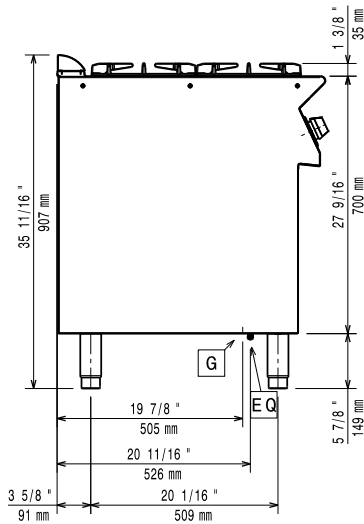

G = Gas connection

Top

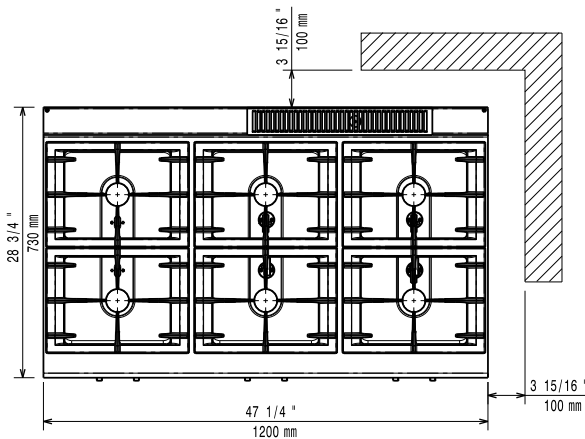

Gas

Gas Power:	371179 (E7GCGL6C00)	33 kW
Standard gas delivery:		Natural Gas G20 (20mbar)
Gas Type Option:		LPG;Town
Gas Inlet:		1/2"

Key Information:

Front Burners Power:	5.5 - 5.5 kW
Back Burners Power:	5.5 - 5.5 kW
Middle Burners Power:	5.5 - 0/5.5 - 0 kW

Back Burners Dimension - mm Ø 60 Ø 60

Front Burners Dimension - mm Ø 60 Ø 60

Middle Burners Dimension - mm Ø 60 Ø 60

External dimensions, Width: 1200 mm

External dimensions, Depth: 730 mm

External dimensions, Height: 850 mm

Net weight: 75 kg

Shipping weight: ISO 9001; ISO 14001; ISO 45001; ISO 50001 kg

Shipping height: 1090 mm

Shipping width: 820 mm

Shipping depth: 1300 mm

Shipping volume: 1.16 m³

If appliance is set up or next to or against temperature sensitive furniture or similar, a safety gap of approximately 150 mm should be maintained or some form of heat insulation fitted.

Certification group: N7CG